

# Panasonic

## Wireless Communication System Operating Instructions Model No. WX-C1011 Series

### Digital Technology

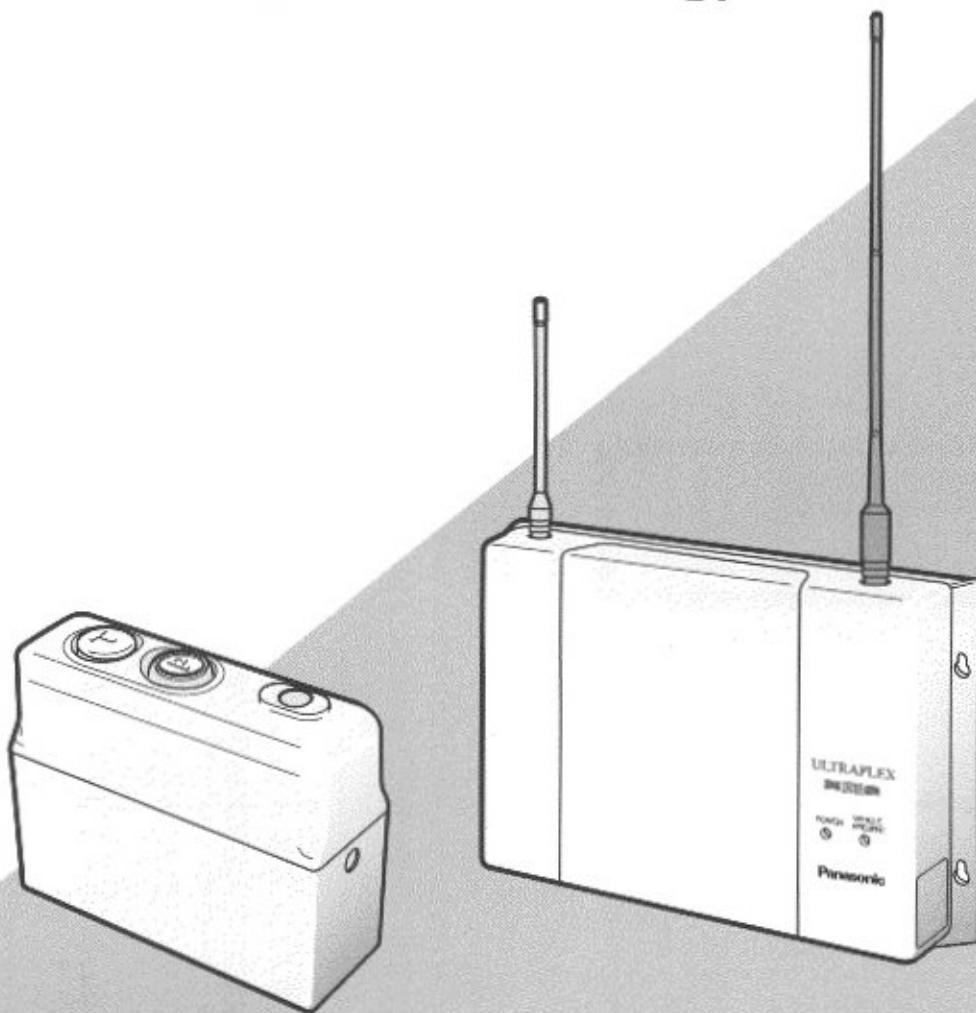

Before attempting to connect or operate this product,  
please read these instructions carefully and save this manual for future use.

# CONTENTS

PREFACE .....	3
PRECAUTIONS .....	3
PANASONIC WX-C1011 SERIES SYSTEM PARTS AND ACCESSORIES .....	4
MAJOR OPERATING CONTROLS AND THEIR FUNCTIONS .....	5
SYSTEM CONNECTIONS AND PREPARATIONS .....	12
OPERATING PROCEDURES .....	15
TROUBLESHOOTING GUIDE .....	16
SPECIFICATIONS .....	17

	<b>CAUTION</b> RISK OF ELECTRIC SHOCK DO NOT OPEN	
<p>CAUTION: TO REDUCE THE RISK OF ELECTRIC SHOCK, DO NOT REMOVE COVER (OR BACK). NO USER-SERVICEABLE PARTS INSIDE. REFER SERVICING TO QUALIFIED SERVICE PERSONNEL.</p>		



SA 1965

The lightning flash with arrowhead symbol, within an equilateral triangle, is intended to alert the user to the presence of uninsulated "dangerous voltage" within the product's enclosure that may be of sufficient magnitude to constitute a risk of electric shock to persons.



SA 1966

The exclamation point within an equilateral triangle is intended to alert the user to the presence of important operating and maintenance (servicing) instructions in the literature accompanying the appliance.

**CAUTION:**

It is a violation of Federal Law to begin operating this system prior to obtaining an FCC Radio License.  
The FCC ID number for this radio equipment is listed below.

**FCC ID : ACK9TAWX-C1011**

The serial number of this product may be found on the right of the unit.  
You should note the serial number of this unit in the space provided and retain this book as a permanent record of your purchase to aid identification in the event of theft.

Model No. \_\_\_\_\_

Serial No. \_\_\_\_\_

**WARNING:**

To reduce the risk of fire or electric shock, do not expose this appliance to rain or moisture.

# PREFACE

The Panasonic Wireless Communication System operates on UHF frequencies. It offers multichannel flexibility making use of state of the art PLL (Phase Locked Loop) technology.

The built-in diversity reception allows the use of two antennas to ensure good performance.

A remote speaker can be added to the system. The Order Taker transceiver is a one piece, light-weight design with an easy-to-install battery.

## New Functions of the WX-C1011 (New Technological Features)

- **DNR (Digital Noise Reduction)**

The DNR function embodies a new technology exclusive to Panasonic, providing natural sound quality without the disagreeable noise peculiar to digital processing.

- **No Talkback Echo**

Digital delay processing eliminates talkback echo from the order taker.

- **TBC (Talkback Automatic Level Control)**

Only human voice is identified in a mixed input of customer voice and noise from the menuboard microphone, then its volume is compared with that of the talk of the order taker to automatically control the talkback volume level.

# PRECAUTIONS

The UHF wireless communication system is a sensitive, high quality instrument and should be regarded as such. Because it is an electrical device, the hazard of electric shock exists, if it is used carelessly.

In order to utilize the instrument to its fullest potential, please consider the following precautions;

1. Handle the equipment with care. This equipment contains sensitive components which can be damaged by improper handling or storage.
2. Refer any servicing to qualified service personnel. Do not attempt to disassemble the Center Module, Order Taker or other units. In order to prevent electrical shock, do not remove screws or covers. There are no user-serviceable parts inside.
3. Use a dry cloth to clean the Center Module, Order Taker or other units if soiled or dirty. If necessary, a mild detergent may be used.
4. Take immediate action if the Center Module or Order Taker becomes wet. Turn the power off and have the unit examined by a qualified service personnel. Do not expose the Center Module or Order Taker to rain or moisture, or attempt to operate the equipment in wet areas. Do not operate the equipment if it is wet.
5. Follow normal safety precautions to avoid personal injury.
6. Properly store beltpack (WITH HEADSET PLUGGED IN) in storage cabinet to prevent damage to equipment.
7. Replace missing microphone and earpiece covers to prevent distortion or loss of audio.
8. Repair or replace any defective components.
9. Turn off the Order Taker when not in use, in order to save the battery life.
10. Charge battery when low battery indicator blinks and a pulsing high/low beep tone is heard in headset.
11. Clean the Battery Charger in accordance with manufacturer instructions at least once a month.
12. Perform regular preventive maintenance by testing accessories (headset, batteries etc.)

# PANASONIC WX-C1011 SERIES SYSTEM PARTS AND ACCESSORIES

■ Center Module  
WX-C1011

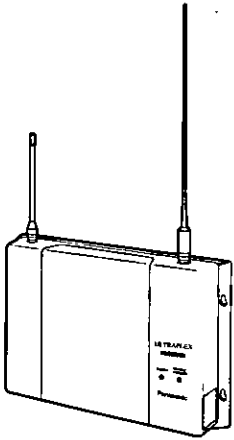

■ Power Transformer  
WX-C516

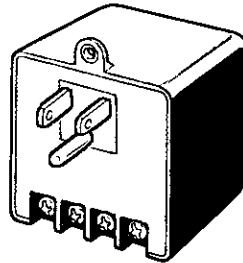

■ Order Taker  
WX-C1020

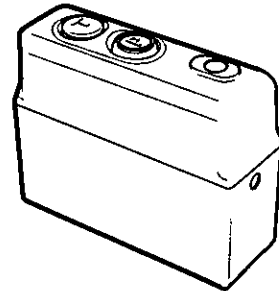

■ Order Taker Case  
WX-C1022

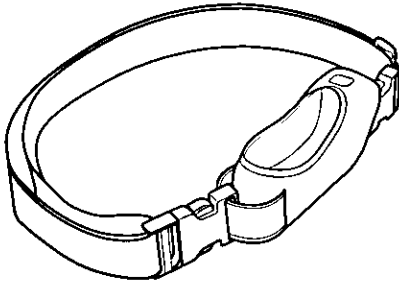

■ Headset  
WX-C1027

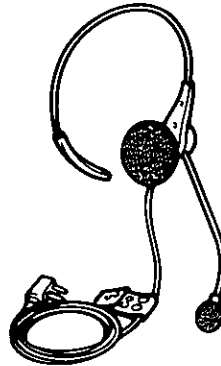

■ Speaker Microphone  
WX-C550

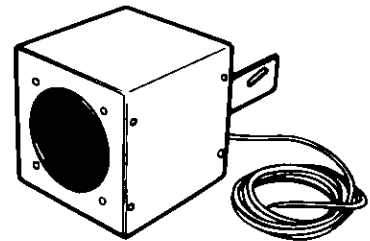

■ External Antenna Kit  
WX-C545

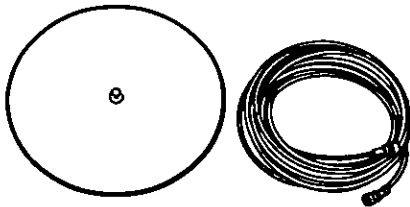

■ Battery Charger  
BC-4

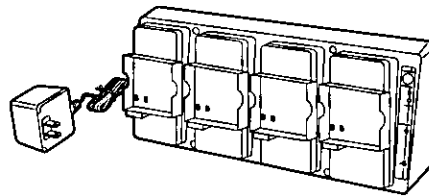

■ Battery  
PB-900

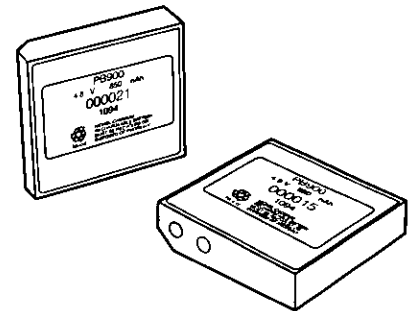

■ Vehicle Detector  
917-1

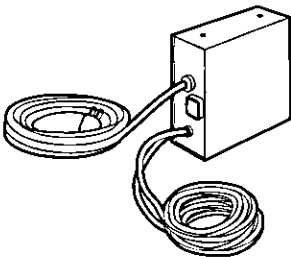

■ Speaker/Loop Cable Kit  
WX-C687

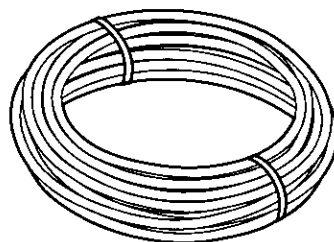

# MAJOR OPERATING CONTROLS AND THEIR FUNCTIONS

## ■ WX-C1011 Center Module

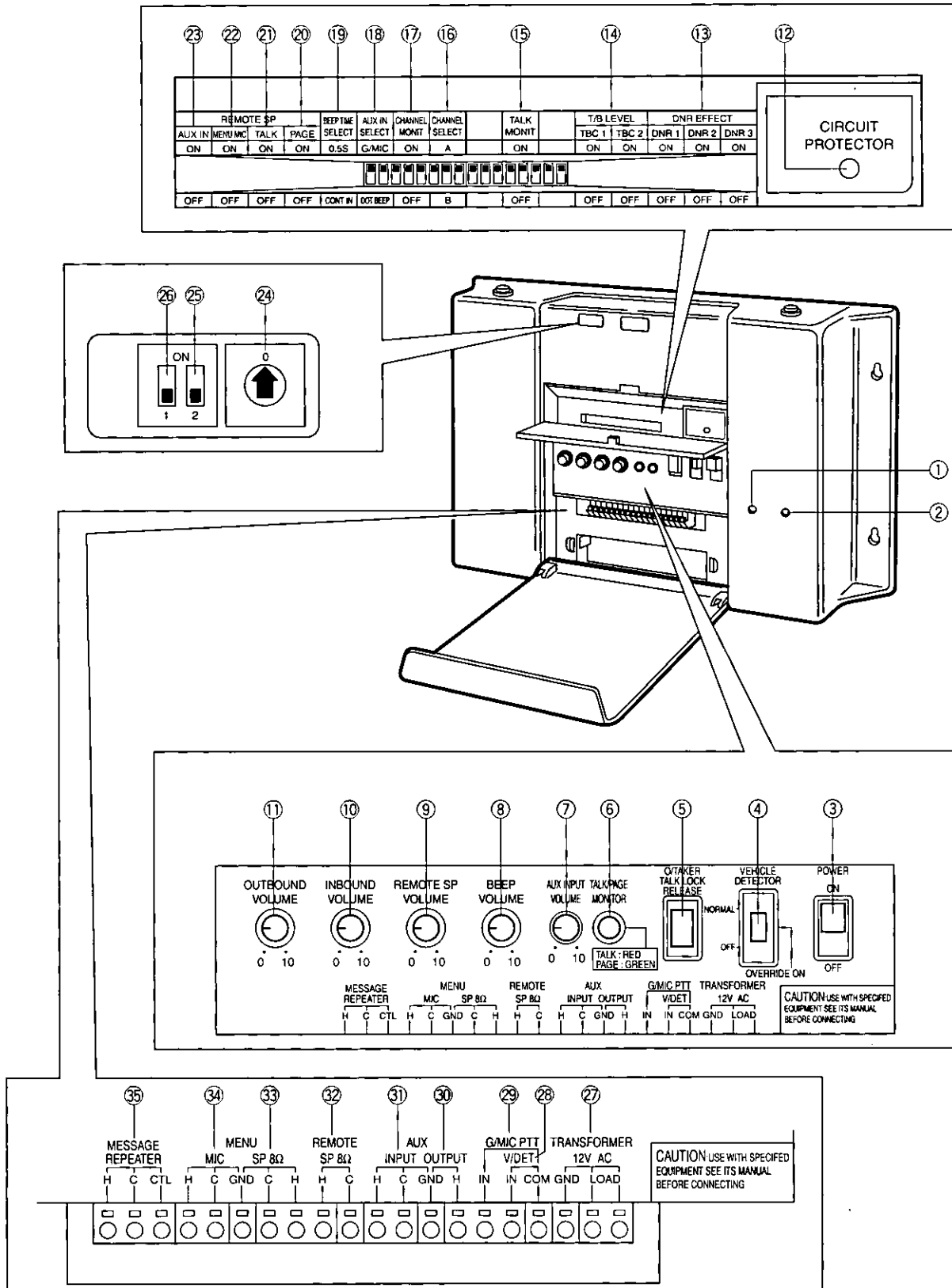

- ① **Power Indicator (POWER)**  
This indicates that the center module is fully power-ed.
- ② **Vehicle Detector Indicator LED (VEHICLE PRESENT)(Amber)**  
This indicates that a vehicle has been detected.
- ③ **Power On/Off Switch (POWER, ON/OFF)**  
This switch turns the power on and off to the center module.
- ④ **Vehicle Detector On/Over-ride On/Off Switch (VEHICLE DETECTOR NORMAL, OVERRIDE ON, OFF)**  
**NORMAL:** Set the switch to the NORMAL position when a vehicle is at the menuboard.  
A beep tone is heard on the Order Taker headset. After the beep tone, the Menuboard Speaker turns on allowing communication to and from the customer. When the vehicle leaves, the Vehicle Detector turns off.  
**OVERRIDE ON:** Set the switch to OVERRIDE ON position.  
The Vehicle Detector is always turned on.  
**OFF:** Set the switch to the OFF position.  
A vehicle at the Menuboard is not detected. No beep tone is heard in Order Taker headset and the Menuboard Speaker remains off.

- ⑤ **Order Taker Talk Lock Release Switch (O/TAKER TALK LOCK RELEASE)**  
This switch is used to release temporarily the Order Taker Talk Lock mode.
- ⑥ **Talk/Page Indicator (TALK/PAGE MONITOR)**  
**Red:** When the Order Taker is in the Talk mode, the indicator lights red.  
**Green:** When the Order Taker is in the Page mode, the indicator lights green.

- ⑦ **Auxiliary Input Level Control (AUX INPUT VOLUME)**  
This controls the input level to the Auxiliary Input Terminal (31).

- ⑧ **Vehicle Detector Beep Volume Control (BEEP, VOLUME)**  
This control sets the vehicle detect alert beep tone for the Order Taker to the optimum level.  
**Caution:** When the Vehicle Detector On/Override On/Off Switch (4) is set to NORMAL position, the beep tone level of the Remote Speaker is also varied by turning this control.

- ⑨ **Remote Speaker Control (REMOTE SP VOLUME)**  
This control sets the output level of the Remote Speaker to the optimum level.  
**Note:** The line marked on this control is a standard position for this adjustment.  
Adjust this control to the suitable position so that feedback does not occur.





- ⑩ **Inbound Volume Control (INBOUND VOLUME)**  
This control sets the sound level from the Menuboard Microphone to the optimum level.  
**Caution:** Adjust this control after setting the Vehicle Detector On/Override On/Off Switch (4) to OVER-RIDE ON position and the Vehicle Detector Indicator lights.  
**Note:** The line marked on this control is a standard position for this adjustment.  
Adjust this control to the suitable position so that feedback does not occur.

- ⑪ **Outbound Volume Control (OUTBOUND VOLUME)**  
This control sets the output level of the Menuboard Speaker to the optimum level for talking to customer.  
**Caution:** Adjust this control after setting the Vehicle Detector On/Override On/Off Switch (4) to OVER-RIDE ON position and the Vehicle Detector Indicator lights.  
**Note:** The line marked on this control is a standard position for this adjustment.  
Adjust this control to the suitable position so that feedback does not occur.

- **The following switches and terminals should be used by qualified service personnel only.**
- **To change the setting of the following switches, turn off the power of the center module, then turn it back on.**

- ⑫ **Circuit Protector (CIRCUIT PROTECTOR)**  
If excessive current flows to the Center Module, the Circuit Protector is triggered. Turn off the Power On/Off Switch (3) first, push in on the red circuit protector and turn on the Power On/Off Switch (3) again. If the circuit protector is soon triggered again, consult your dealer or authorized service center for assistance.

- ⑬ **DNR (Digital Noise Reduction) Effect Level (DNR EFFECT DNR1, DNR2, DNR3, ON/OFF)**  
These switches are used for noise reduction level setting.  
The more the noise is reduced, the lower will be the sound quality. The table below shows the relationship between noise reduction level and sound quality.  
No setting should be done other than shown in the table.

Setting	Noise Reduction Level	Sound Quality	Remarks
DNR1 DNR2 DNR3 	—	—	No DNR processing
DNR1 DNR2 DNR3 	Low	High	For a relatively quiet environment
DNR1 DNR2 DNR3 	Normal	Normal	For a general environment. This balanced setting is recommended.
DNR1 DNR2 DNR3 	High	Low	For a very noisy environment. Not so recommended because it seriously affects sound quality.

**14 Talkback Level Control (T/B LEVEL TBC1, TBC2, ON/OFF)**

These switches are used for order taker talkback level setting.  
Change the settings if talkback level is too high.

Setting	Talkback Level	Remarks
TBC1 TBC2 	-6 dB	Normally set to this position Talkback level set to 50%
TBC1 TBC2 	-9 dB	Talkback level set to 35%
TBC1 TBC2 	-12 dB	Talkback level set to 25%
TBC1 TBC2 	-	Talkback off

**15 Talk Monitor On/Off Switch (Supplementary Mode Switch) (TALK MONIT OF/OFF)**

This DIP switch should be normally be set to the OFF position.  
Consult your servicing dealer before attempting to change this switch.

**16 Channel Selection Switch (CHANNEL SELECT, A/B)**

This switch selects the frequency between channel "A" and "B" licensed by the FCC. This switch is normally set to the "A" position. The switch can be set to "B" position if external interference occurs.

**17 Channel Monitor On/Off Switch (CHANNEL MONIT, ON/OFF)**

This switch is used to check if the desired channel is already used by other systems at the time of installation. This switch is normally set to OFF position.  
**Note:** The Frequency Setting Switch (24) can only be activated, when the switch is set to the ON position.

**18 Auxiliary Input Selection Switch (AUX IN SELECT, G/MIC / DDT BEEP)**

This switch selects the Auxiliary Input Level.  
**G/MIC (Gooseneck Microphone):**

This can be used as a wired system.  
(Input : -62 dBV, balanced)

**DDT BEEP (Double Drive Through Beep):**

This can be used as a double drive through system.  
(Input : -20 dBV, balanced)

**19 Beep Time Selection Switch (BEEP TIME SELECT, 0.5S/CONTIN)**

This switch selects duration of beep tone between 0.5 seconds and continuous modes.

**0.5 S:** The beep tone sounds for 0.5 seconds after detecting the vehicle.

**CONTIN:** After the vehicle is detected by the vehicle detector, the beep tone continuously sounds until the Talk Switch (43) on the Order Taker has been pressed.

**20 Page On/Off Switch (REMOTE SP PAGE, ON/OFF)**

To monitor crew-to-crew Order Taker conversation with the Remote Speaker, set this switch to the ON position.

**21 Talk On/Off Switch (REMOTE SP TALK, ON/OFF)**

To monitor crew-to-customer Order Taker conversation with the Remote Speaker, set this switch to ON position.  
**Note:** Do not turn on this switch and Menuboard Microphone On/Off Switch simultaneously.

**22 Menuboard Microphone On/Off Switch (REMOTE SP MENU MIC, ON/OFF)**

To monitor the voice of a customer by using the Remote Speaker, set this switch to ON position.  
**Note:** Do not turn on this switch and the Talk On/Off Switch simultaneously.

**23 Auxiliary Input On/Off Switch (REMOTE SP, AUX IN, ON/OFF)**

Set the switch to the ON position for the Remote Speaker Output mode.

**24 Frequency Setting Switch**

This switch selects the frequency from 8 positions.  
**Note:** The "9" and "0" positions are error mode.

**25 Monitor On/Off Switch (ON/2)**

This switch should be used as the FCC Channel Monitor when using the Channel Monitor On/Off Switch (17).  
After setting the Frequency Setting Switch (24) to the desired position, set this switch.  
**ON:** When the switch is set to the ON position, FM noise will be output when there is no signal.  
**2:** When the switch is set to the 3 position, the noise squelch function will be activated.

Monitor On/Off Switch (26) setting position	2	ON
Channel Monitor On/Off Switch (17) setting position		
MONIT OFF	Normal operation mode	-
MONIT ON	Interference confirmation mode	FCC channel Monitor mode

- ②⑥ **Continuos Transmission On/Off Switch (ON/1)**  
**ON:** When the switch is set to the ON position, the transmission starts by turning on the power of the Center Module.  
**1:** When the switch is set to the 1 position, the transmission starts with the following conditions.
- The Vehicle Detector On/Override On/Off Switch (4) has been set to ON or OVERRIDE ON position.
  - Page or Talk Switch on the Order Taker has been pressed.
- ②⑦ **Transformer Terminal (TRANSFORMER 12V AC GND, LOAD)**  
Connects with the Power Transformer WX-C516.
- ②⑧ **Vehicle Detector Terminal (V/DET IN, COM)**  
Connects with the Vehicle Detector Output Terminal.
- ②⑨ **Gooseneck Microphone PTT Terminal (G/MIC PTT IN, COM)**  
Connects with the PTT cable of the Gooseneck Microphone.
- ③① **Auxiliary Output Terminal (AUX OUTPUT GND, H)**  
Connects with the Auxiliary Input Terminal of the other Center Module.  
The auxiliary output level is -20 dB, unbalanced.  
**Note:** When using the Gooseneck microphone, connect the monitor speaker with amplifier to this terminal.
- ③① **Auxiliary Input Terminal (AUX INPUT H, C, GND)**  
Connects with the Auxiliary Output Terminal of the other Center Module or with the gooseneck microphone.  
When connecting the gooseneck microphone, set the Auxiliary Input Selection Switch (18) to the G/MIC position.
- ③② **Remote Speaker Terminal (REMOTE SP 8Ω H, C)**  
Connects with the Remote Speaker.  
The audio level is 8 ohms, 2 W, unbalanced.
- ③③ **Menu Speaker Terminal (MENU SP 8Ω GND, C, H)**  
Connects with the Menuboard Speaker WX-C550.  
The audio level is 8 ohms, 2 W, unbalanced.
- ③④ **Menu Microphone Terminal (MENU MIC H, C, GND)**  
Connects with the Menuboard Microphone.  
The audio level is -61 dBV, 8 ohms, balanced.
- ③⑤ **Message Repeater Input (MESSAGE REPEATER H, C, CTL)**  
Connect the message repeater here. The signals from this input are output to the menuboard speaker, REMOTE speaker and AUX output. The message is muted when the TALK switch (43) is pressed. The input level is -24 dBV, unbalanced.  
**Note:** CTL permits message repeater control by pressing the TALK switch (43). It is an open collector type and is to be pulled up for use.



## ■ WX-C1020 Order Taker

**Note:** To prevent damage, use a miniature screwdriver to open this cover.

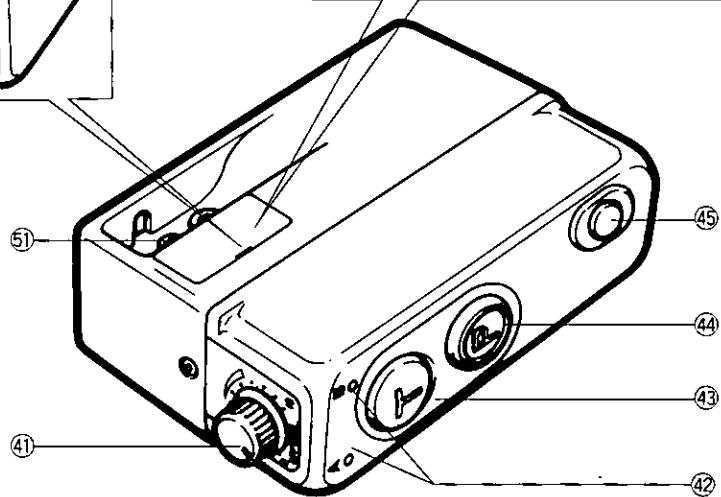
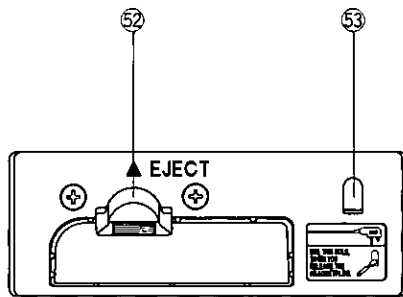
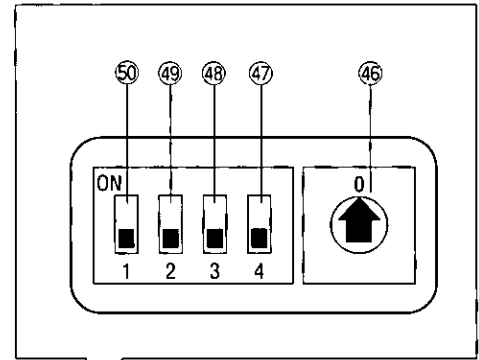
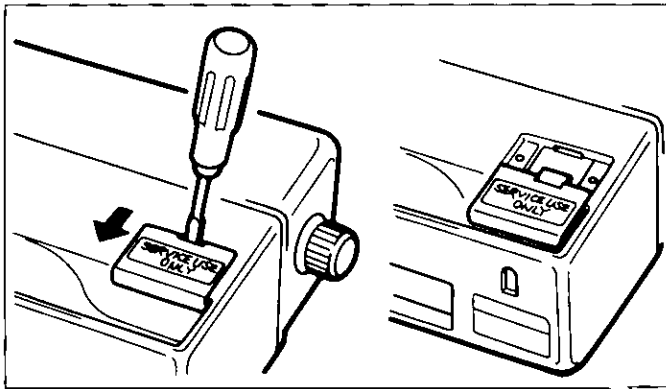

### ④① Volume Control (VOL, OFF/0/10)

This control is used to turn the power on or off and adjusts the volume of the earphone output on the headset.

Whenever the unit is not in use, turn off the power to save the battery life.

### ④② Battery and Power Indicators (A/B)

These indicate the battery and operating condition as follows.

**A:** When the unit is in Channel A mode selected by the A/B Selection Switch (45) (Normal operating condition), this LED lights.

**B:** When the unit is in Channel B mode selected by the A/B Selection Switch (45) (Back-up operating condition), this LED lights

**Blink** (0.2 sec. On and 4.8 sec. Off) :  
Battery Alarm mode

**Blink** (0.5 sec. On and 0.5 sec. Off) :  
This unit is in the Talk-lock mode.

**Blink** (A and B are turning on alternately) :  
This unit is in the error mode.

In this mode, turn off the power of the Order Taker, then turn it back on.

### ④③ Talk Switch (T)

Pressing the Talk Switch allows transmission to the Center Module along with sending the Talk tone.

Talk-Lock On or Off mode can be selected by the Talk-Lock On/Off Switch (47) on the Order Taker.

To release the Talk-Lock mode immediately, press the Order Taker Talk Lock Release Switch (5) on the Center Module.

#### **Notes:**

1. If pressing the Page Switch or A/B Selection Switch (45) simultaneously with the Talk Switch, the Talk mode will not work.
2. The transmission to the Center Module is available with only one Order Taker at a time.  
The other Order Takers can not access during the transmission.

### ④④ Page Switch (P)

While pressing the Page Switch, you can speak to the store personnel wearing the Order Taker without being heard by a customer at the menuboard speaker. After speaking, release this switch immediately to listen to the response.

**Note:** When pressing the Talk Switch or A/B Selection Switch simultaneously with this switch, the Page mode can not work.

④⑤ **A/B Selection Switch (A/B)**

This switch selects either Channel A or B on the Order Taker by using the SDT/DDT Selection Switch (50) on the Order Taker.

By setting the SDT/DDT Selection Switch (50) to the DDT position, the A or B channel can be selected by this switch.

By setting the SDT/DDT Selection Switch (50) to the SDT position, the A/B Channel Selection is not possible.

**Note:** When pressing the Page Switch or Talk Switch simultaneously with this switch, the channel change is not possible.

**The switches in the dotted line should be used by service personnel or system installers only.**

④⑥ **Frequency Setting Switch**

This switch selects the frequency from 8 positions .

**Note:** The 9" and "0" positions are error mode.

The setting position should be matched to the position of the Frequency Setting switch (24) on the center module.

④⑦ **Talk-Lock On/Off Switch (ON/4)**

This switch selects the Hands-Free On/Off mode.

**ON:** Electronic Lock Mode for Talk Switch

When this switch is set to the ON position, the Talk-lock function can be released by Order Taker Talk Lock Release Switch (5) on the Center Module.

**4:** PTT (Press to Talk) Mode for Talk Switch

④⑧ **Tone Squelch Switch (ON/3)**

This switch selects the mode of Tone Squelch method.

**ON:** When this switch is set to the ON position, the audio is output in disregard of the Tone Squelch signal from the Center Module.

**3:** When this switch is set to the 3 position, the audio is output detecting the Tone Squelch signal from the Center Module.

Set to the position normally.

④⑨ **Single Drive Through Lane Selection Switch (ON/2)**

**ON:** When this switch is set to the ON position, Channel B can be selected as an initial condition after the power on the Order Taker is turned on. (The spare channel is used when external interference occurs)

**2:** When this switch is set to the 2 position, Channel A can be selected as an initial condition after the power on the Order Taker is turned on.(Usual position)

**Note:** The switching can be confirmed by using the Battery and Power Indicators (42) as shown below.

Red LED lights with the Channel A selection.

Green LED lights with the Channel B selection.

⑤⑩ **Single Drive Through/Double Drive Through Selection Switch (ON/1)**

**ON:** When this switch is set to the ON position, the A/B Selection Switch (45) can work. (DDT (Double Drive Through) mode)

**1:** When this switch is set to the 1 position, the A/B Selection Switch does not work. (SDT (Single Drive Through) mode)

**Note:** When the setting for the 46 - 50 switches inside the cover is changed, turn off the power, then turn it on.

⑤⑪ **Headset Jack**

Plug in the headset plug to this jack securely, before fitting the Order Taker Case.

The jack having a smaller diameter is for the microphone and the larger one is for the earphone.

⑤⑫ **Battery Lock Lever (EJECT)**

Slide this lever to the EJECT position to release the battery for replacement.

⑤⑬ **Headset Plug Release Hole**

This hole is used to release the Headset plug.

**Caution:** Be sure to use a miniature screwdriver for releasing the Headset Jack. To prevent damage of the equipment, do not pull the Headset Jack Cord.

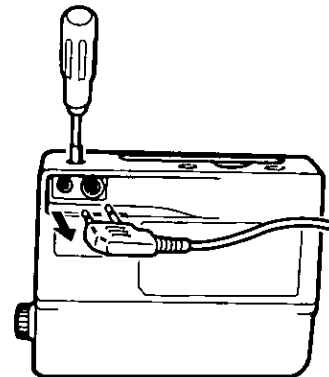

## ■ WX-C550 Speaker Microphone

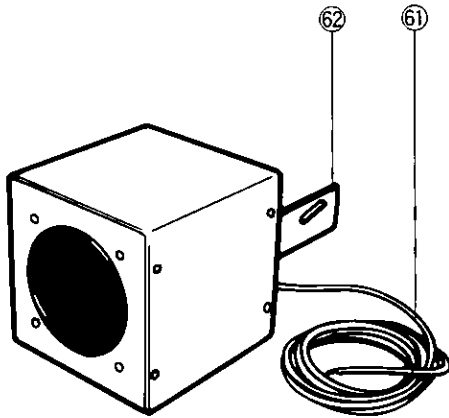

### ⑥1 Input Cord

A pigtail cord is provided for the speaker input. Its length is approximately 3 meters.

### ⑥2 Mounting Bracket

AU-type mounting bracket with screw holes is provided as a standard accessory with the WX-C550.

## ■ WX-C516 Power Transformer

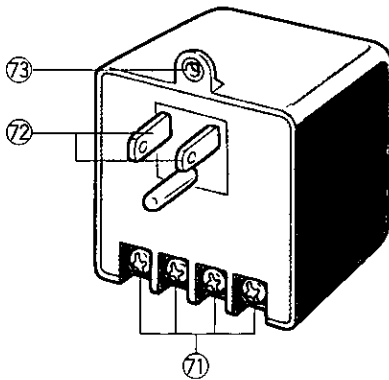

### ⑦1 Output terminal (SPARE, LOAD, GRD (Ground))

12 V AC, 1600 mA (Listed) is provided at the two terminals indicated as "LOAD" to be used for the Center Module WX-C1011.

#### Caution:

Be sure to connect the wire between the GRD (GROUND) of this terminal and that in the Transformer Terminal (27) on the Center Module.

To prevent fire or shock hazard, the UL listed Power Supply Cord, style SVT should be used for the cable for 12 V AC terminal.

### ⑦2 Power Plug

To prevent fire or electrical shock, connect this directly to a 3-plug grounded receptacle of 120 V AC, 60Hz.

### ⑦3 Mounting Hole

A small hole is required to secure the Power Transformer to the wall plates.

## ■ WX-C1027 Headset

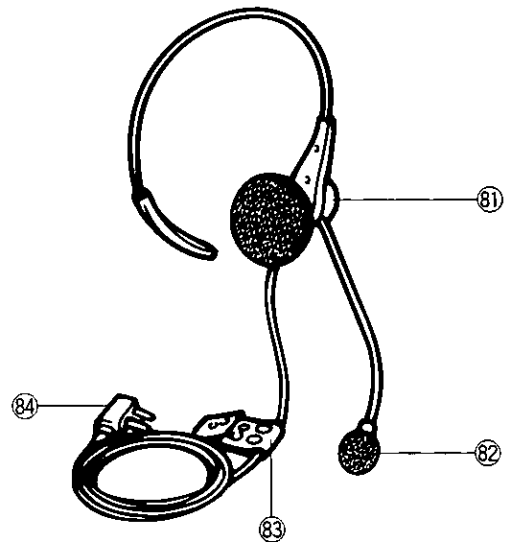

### ⑧1 Earphone

### ⑧2 Microphone

### ⑧3 Cable Clips

Use these clips to attach the cable to your uniform.

### ⑧4 Headset Plug

## ■ WX-C545 External Antenna Kit

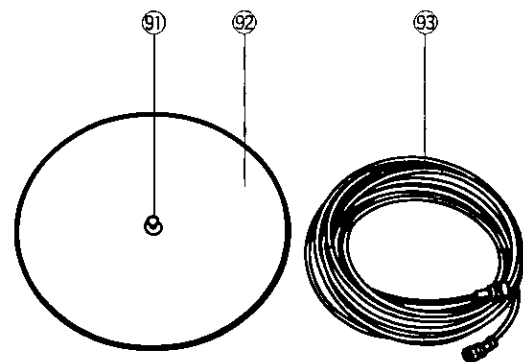

### ⑨1 Antenna

### ⑨2 Antenna Mounting Plate

### ⑨3 Coaxial Cable

# SYSTEM CONNECTIONS AND PREPARATIONS

**Caution:** The installation described below should be made by qualified service personnel or system installers.

## ■ System Connections

Shown below is an example of a basic system connection.

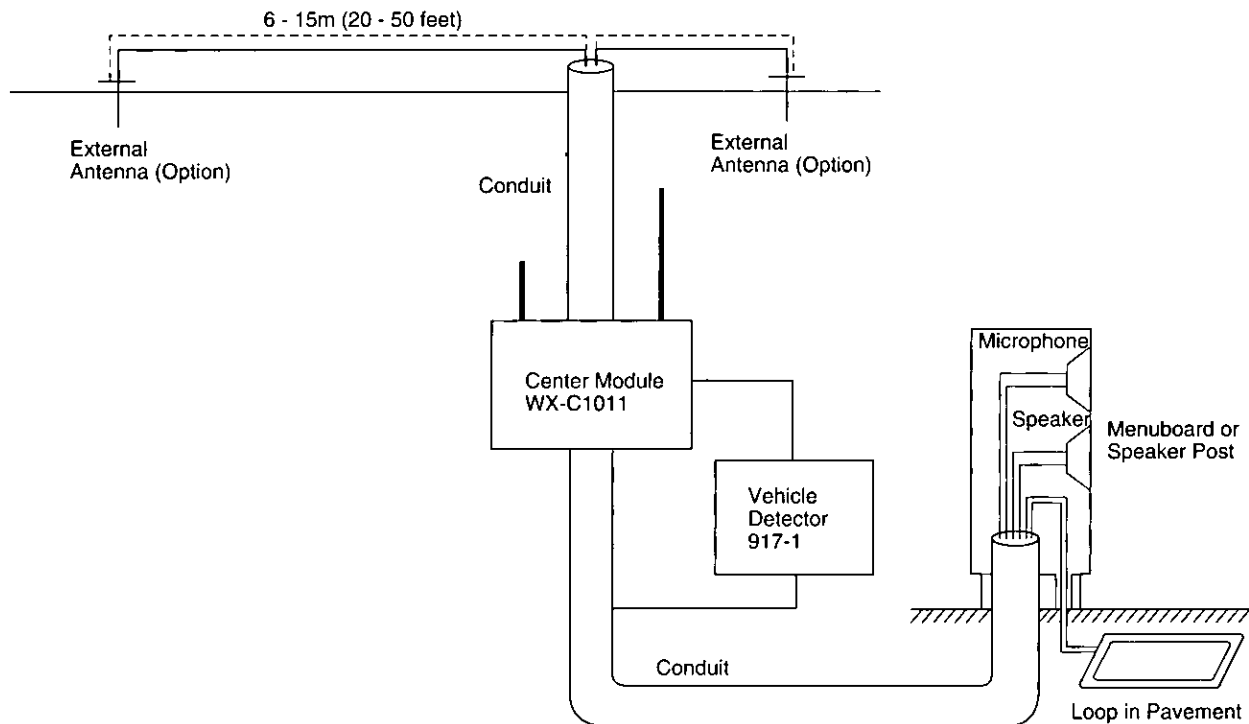

- The distance between microphone and speaker should be approx. 5cm (2 inches) or more.

## ■ Battery Charge and Replacement

Refer to the Operating Instructions provided with the battery charger. The following procedure is a summary of battery replacement and charging.

1. Replace the Battery when the Battery and Power Indicator on the Order Taker blinks and the pulsing high/low beep tone is heard in the headset.
2. Slide the Battery Lock Lever on the Order Taker toward the EJECT position and pull out the discharged Battery.
3. Insert the discharged Battery into the battery compartment of the Battery Charger and confirm the RED LED on the front panel of the Battery Charger lights.
4. When the Battery is fully charged, the GREEN LED on the front panel of the Battery Charger lights. Use only fully-charged batteries.
5. Insert the fully-charged Battery into the battery compartment of the Order Taker.

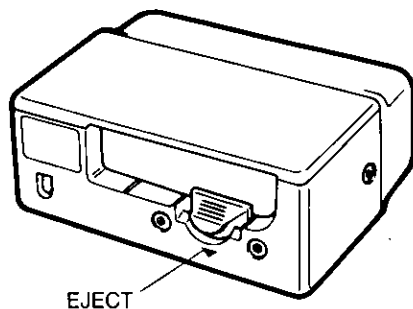

**Caution:** Do eject the battery with care.  
Otherwise, the battery may be damaged.

### ■ Cautions:

1. Do not shortcircuit between  $\oplus$  and  $\ominus$  terminals of battery.
2. Read the Battery Charger Instruction Manual completely for your personal safety and correct operation.
3. Be sure to charge the battery only after hearing the high/low beep tone in the headset. Other-wise, the operating life time may be shortened.
4. Use a fully charged new battery if the battery operating life time has been shortened by incorrect charging.

## ■ Assembly and Wearing Belt Pack

1. Take a fully charged battery from the Battery Charger.

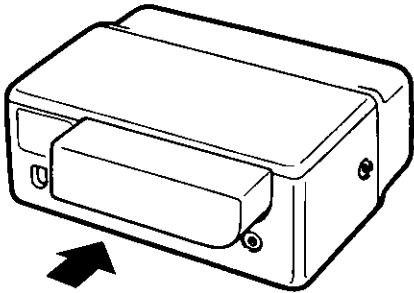

2. Insert the battery (contact end first) into the battery compartment of the Order Taker completely.

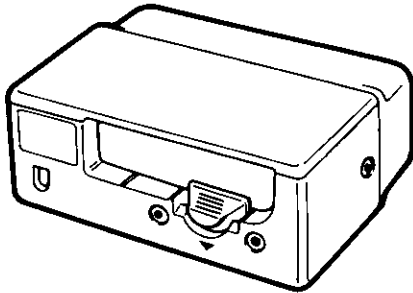

3. Insert the Headset Plug into the Headset Jack on the Order Taker and confirm that the plug is completely inserted into the jack.

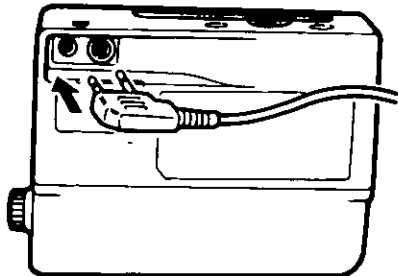

4. Insert the Order Taker into the WX-C1022 Order taker Case.

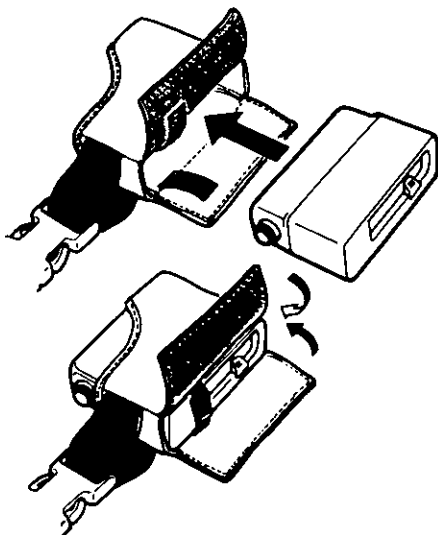

5. Unsnap the buckle on the belt of Order Taker Case.
6. Put the Order Taker case on the left side of your waist.

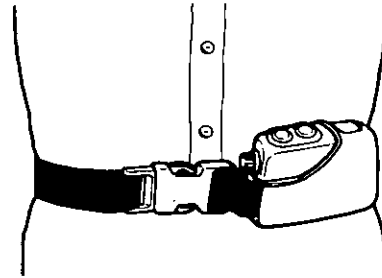
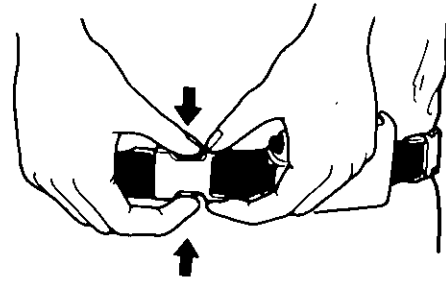

**Note:** When putting the Order Taker Case on the right side of your waist, unsnap the buckle on the belt and re-attach it in reverse as shown below.

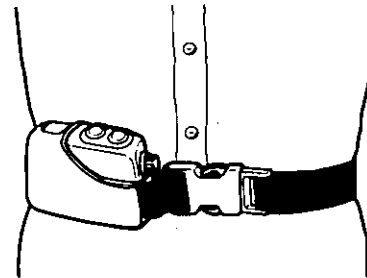

7. Snap the buckle on the belt of Order Taker Case.

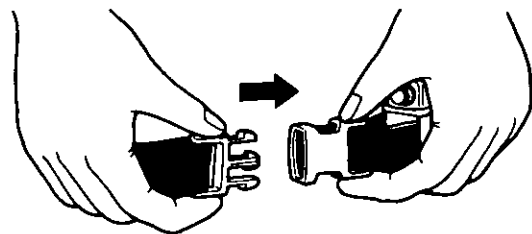

8. Fasten the belt tightly enough so it will not move around on your waist.
9. Fasten both uniform clips to your clothing, on the back.
10. Adjust the headset band until it fits comfortably and securely.

11. Position the microphone boom as shown in figure below.

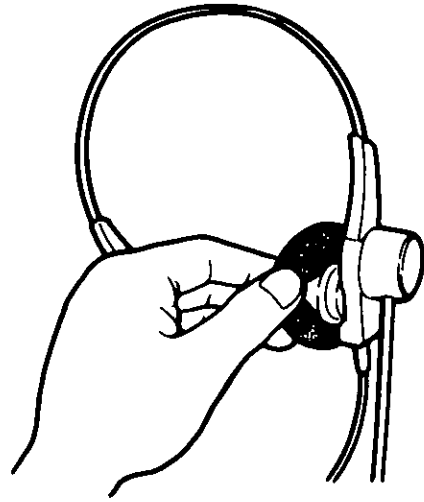

Earspeaker Cover Replacement

### Replacement of covers and cushion of headset

The earspeaker cover and microphone cover are washable. After cleaning, be sure they are dry before returning them to the headset.

Be careful when you slip it on or off the earpiece.

The earspeaker cover, microphone cover and headpad cushion are replaceable for sanitary purposes. To order the Headset Cover Kit WX-C1025, call your dealer.

#### IMPORTANT

A microphone cover must be used at all times. Failure to do so CAN cause debris to accumulate in the microphone port opening and result in an inoperative headset.

#### ATTENTION:



**Ni-Cd**

The product that you have purchased contains a rechargeable battery. The battery is recyclable. At the end of its useful life, under various state and local laws, it may be illegal to dispose of this battery into the municipal waste stream. Check with your local solid waste officials for details in your area for recycling options or proper disposal.

### ■ Maintaining the Equipment (Non-Scheduled Maintenance)

**Be sure to use the microphone cover for this headset.**

**Otherwise, the headset may be damaged by dust or oil.**

### Headpad Cushion Replacement

- Peel off the old cushion
- Clean surface with a warm solution of household cleaner.
- Remove the protective tape from the new cushion.
- Position the new cushion on the headpad and press in place.

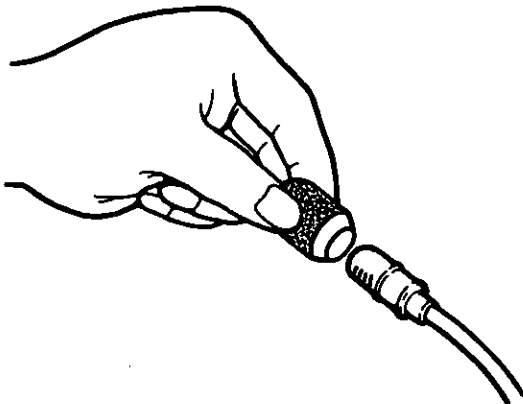

Microphone Cover Replacement

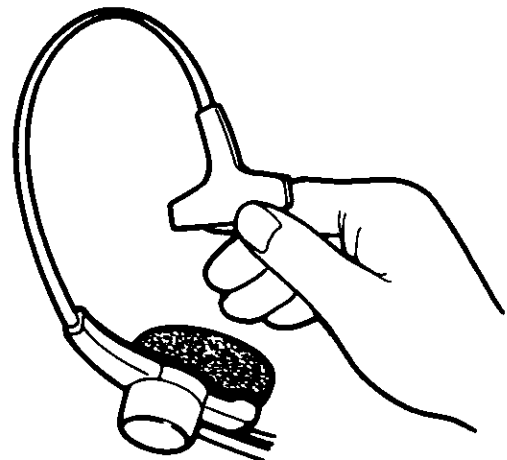

Headpad Cushion Replacement

# OPERATING PROCEDURES

## ■ Communication with Customers

Any store personnel wearing the Order taker with Headset can have two-way conversations with Drive-thru customers. All personnel wearing the Order Taker can have two-way conversations.

1. Turn the Volume Control (41) (VOL, OFF/10) on the Order Taker to the middle position.

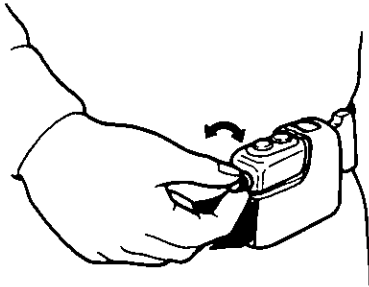

2. When a vehicle arrives at the menuboard speaker, you will hear a tone in your headset.

**Note:** The tone duration depends on which switch position is chosen in the Center Module. The tone will be either 0.5 seconds or continuous mode. See detail on major operating controls and their functions in this instruction on page 5.

3. Talk lock mode and PTT (Press Talk) mode are provided for the Talk function. Consult qualified service personnel for the proper talk mode setting.
4. Listen to the Customer response.
5. Adjust the Volume Control on the Order Taker to the desirable level for the incoming transmission (customer's response).

### **Cautions:**

1. Only one person can transmit at a time. If another person tries to use the system while someone else is talking or paging, they will hear a continuous beep in the headset.
2. Be sure to make the distance for the communication between/among the Order Takers more than 30 cm (1 foot), and between/among the Center Module and Order Takers more than 1 meter (3 feet).
3. When the Vehicle Detector is turned on after setting the Beep Time Selection Switch (19) to the 0.5S position and turning on the Vehicle Detector, the beep tone can not be heard.
4. When pressing the Talk Switch on the Order Takers simultaneously, a garbled sound may occur.

## ■ Communication with Other Store Personnel

Store personnel wearing the Order Taker can communicate with each other without being heard by customers.

1. While pressing the Page Switch (44)(PAGE), speak into the microphone at a normal level. Short beep tone confirms to the users that they are operating in the page mode.

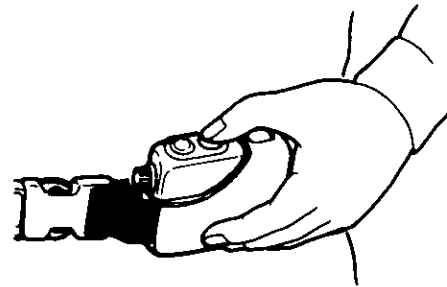

**Note:** When pressing Page Switch (44) on two Order Takers simultaneously, a garbled sound may occur.

2. Release the Page Switch (44) immediately after speaking. You can hear only when the Page Switch is released.
3. Listen to the response from other store personnel.

**Caution:** Only one person can transmit at a time. If another person tries to use the system while someone else is talking or paging, they will hear a continuous beep in the headset.

# TROUBLESHOOTING GUIDE

**Phenomenon :**

Cannot communicate between Order Taker units or to Menuboard.

**Check Points :**

1. Is the Power On/Off Switch on the Center Module turned on.
2. Check A.C. power at outlet.
3. Push red circuit Breaker Button.
4. Consult your dealer or authorized service center.

**Phenomenon :**

Cannot talk to or hear customer at Menuboard.  
Communication between store personnel in store is O.K.

**Check Point :**

Check to see if the Vehicle Detector Indicator (2) (VEHICLE PRESENT) located in the lower right corner of Center Module, lights when a vehicle drives up the Speaker post/Menuboard, if not check the following.

1. Is the Vehicle Detector plugged in ?
2. Does the VEHICLE PRESENT Indicator light in the lower right corner of the Center Module?  
If not check the A.C. outlet and fuse of the Vehicle Detector.  
If the power and fuse are operational, consult the authorized service center.

**Phenomenon :**

Speaker is always live from customer.

**Check Points :**

1. Reset the Vehicle Detector. With no car at the Speaker post/Menuboard, remove and reinstall the fuse on the side of the Detector.
2. If the same phenomenon remains after performing step #1, consult your dealer or authorized service center.

**Phenomenon :**

Constant beep when a car comes to the Speaker post/Menuboard. (Stops when the Talk button is pressed)

**Check Points :**

Incorrect switch setting of the Beep Time Selection Switch (19) on the Center Module. Set this switch to 0.5S position.

**Phenomenon :**

Cannot page or talk in certain areas.

**Check Points :**

1. Make sure there is no metal obstruction blocking the Center Module.
2. It may be necessary to extend one or both antennas to areas where the reception is poor.  
Consult your dealer or authorized service center.



# SPECIFICATIONS

## WX-C1011 Center Module

Operating Frequency:	Transmit; 469.0125 MHz - 469.4125 MHz Receive; 464.0125 MHz - 464.4125 MHz
Type of Emission:	F3
Type of Antenna:	1/4 wavelength whip antenna (short white antenna) 1/2 wavelength whip antenna (long black antenna)
Power Supply:	12 V AC, 60 Hz (Use WX-C516 Power Transformer)
Power Consumption:	13 W
Menuboard Speaker Output:	2 W, 8 $\Omega$
Remote Speaker Output:	2 W, 8 $\Omega$
Vehicle Detector Input:	Normally Open (close contact requires vehicle presence)
Dimensions:	330 mm (W) X 210 mm (H) X 62 mm (D) 13" (W) X 8-1/4" (H) X 2-7/16" (D)
Weight (Including Antenna) :	1.44 kg (3.17 lbs.)

Dimensions and weights indicated are approximate.  
Specifications are subject to change without notice.

